



DIAC

Features

1. V_{BO} : 40V
2. Breakover voltage range: 35 to 45V



Applications

Functioning as a trigger diode with a fixed voltage reference, the LLDB4 can be used in conjunction with triacs for simplified gate control circuits or as a starting element in fluorescent lamp ballasts.

Absolute Maximum Ratings

(Limiting values)

Parameter	Symbol	Value	Unit
Repetitive peak on-state current ($t_p=20\mu s$ $F=120$ Hz)	I_{TRM}	2	A
Operating junction temperature range	T_j	-40 ~ +125	°C
Storage temperature range	T_{stg}	-40 ~ +125	°C

Stresses exceeding maximum ratings may damage the device. Maximum ratings are stress ratings only. Functional operation above the recommended operating conditions is not implied. Extended exposure to stresses above the recommended operating conditions may affect device reliability.



Electrical Characteristics

(T_j=25°C unless otherwise specified)

Parameter	Symbol	Test Conditions	Value	Unit	
Breakover voltage*	V _{BO}	C=22nF**	MIN.	35	V
			TYP.	40	
			MAX.	45	
Breakover voltage symmetry	V _{BO1} -V _{BO2}	C=22nF**	MAX.	±3	V
Dynamic breakover voltage*	ΔV	V _{BO} and V _F at 10mA	MIN.	5	V
Output voltage*	V _O	see diagram 2(R=20Ω)	MIN.	5	V
Breakover current*	I _{BO}	C=22nF**	MAX.	50	μA
Rise time*	t _r	see diagram 3	MAX.	2	μs
Leakage current*	I _R	V _R =0.5V _{BO} max	MAX.	10	μA

*Applicable to both forward and reverse directions.

**Connected in parallel to the device.

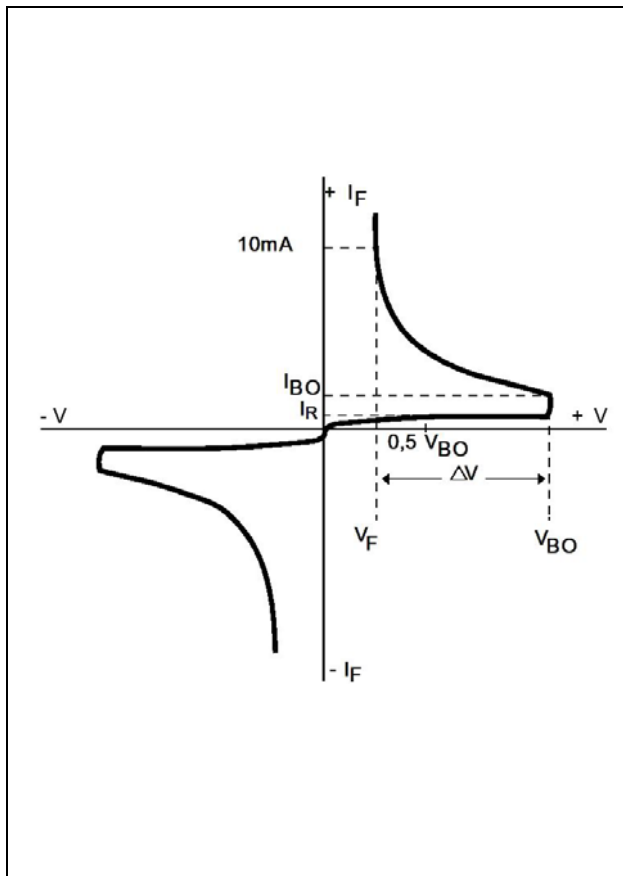

Diagram 1. Voltage – current characteristic curve

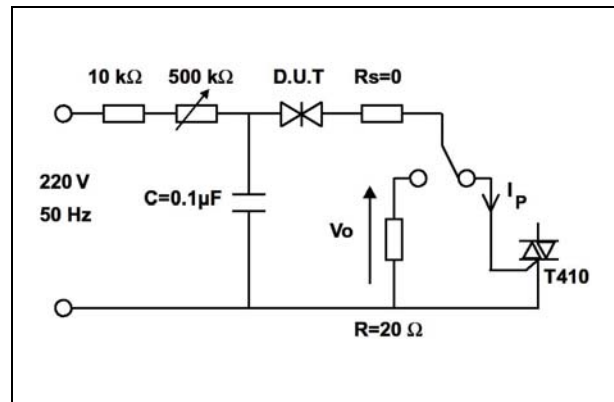

Diagram 2. Test circuit

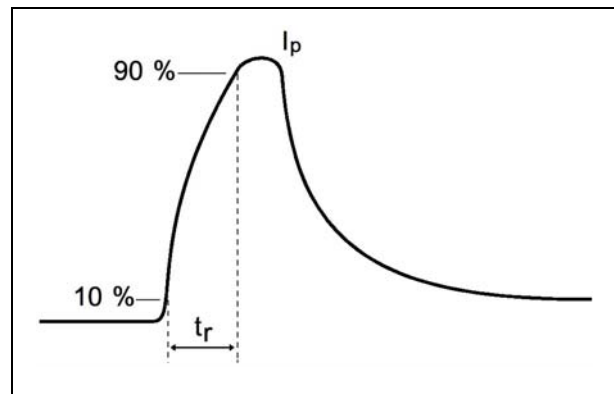

Diagram 3. Rise time measurement

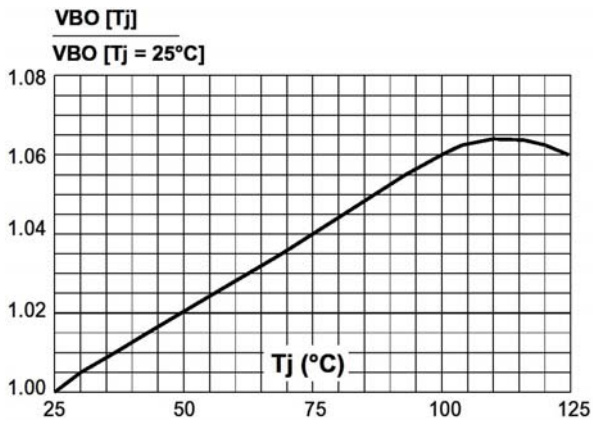

Figure 1. Relative variation of VBO versus junction temperature (typical values)

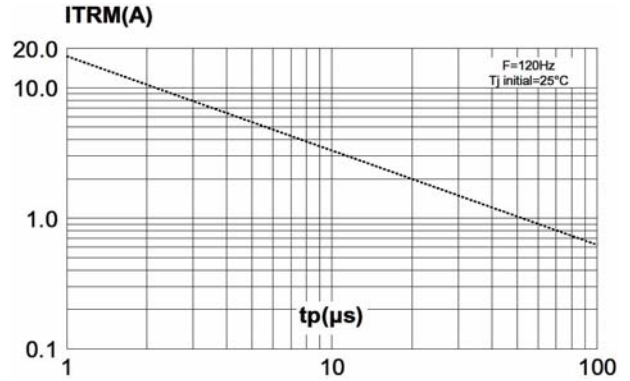

Figure 2. Repetitive peak pulse current versus pulse duration (maximum values)

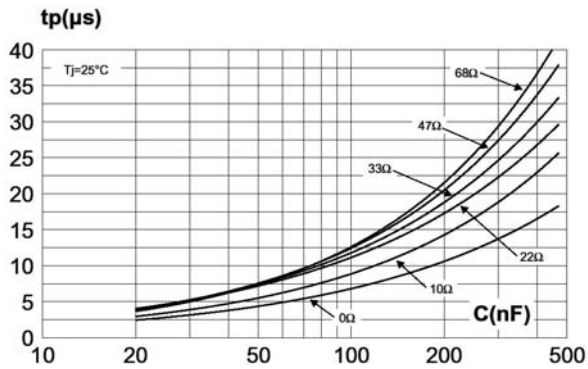
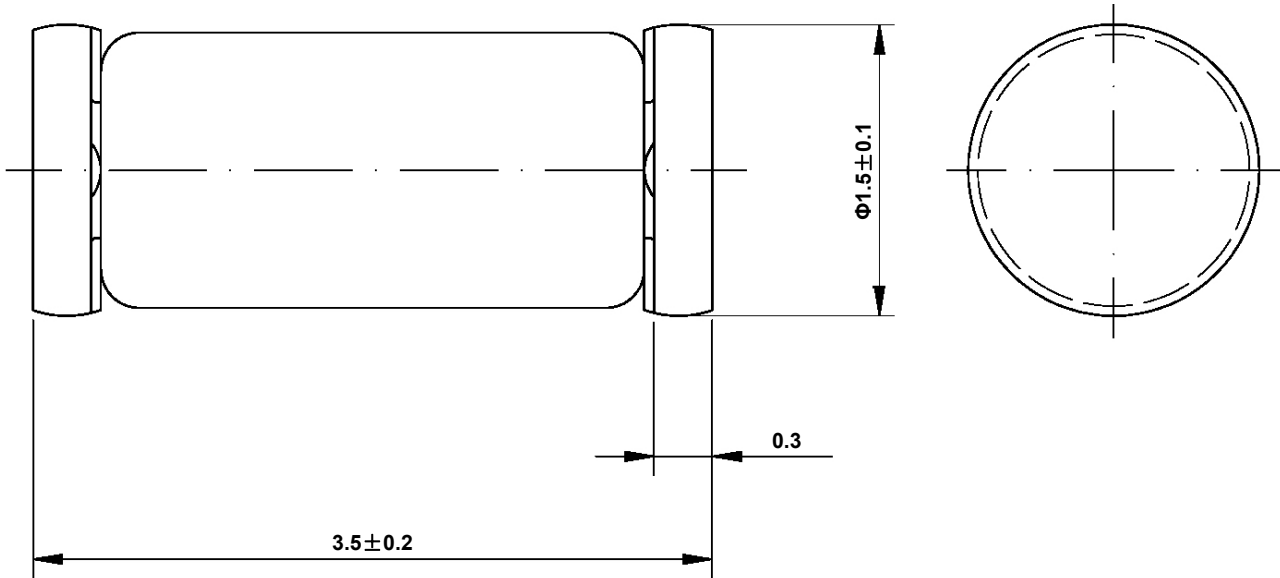

Figure 3. Time duration while current pulse is higher 50 mA versus C and Rs (typical values)



Dimensions in mm



Glass Case
Mini Melf / SOD 80
JEDEC DO 213 AA