

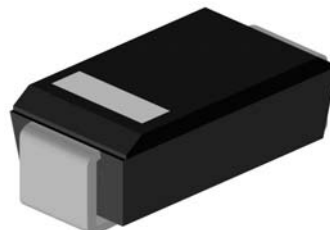

## Zener diode

### Features

1. 1.0W power dissipation
2. For surface mounted applications
3. Zener voltage 5.1V to 39V
4.  $V_Z$ -tolerance $\pm 5\%$



### Applications

Voltage stabilization

### Absolute Maximum Ratings

$T_j=25^\circ\text{C}$

Parameter	Test Conditions	Type	Symbol	Value	Unit
Power dissipation	$T_{amb}\leq 50^\circ\text{C}$		$P_d$	1	W
Z-current			$I_{ZM}$	$P_d/V_Z$	mA
Junction temperature			$T_j$	175	$^\circ\text{C}$
Storage temperature range			$T_{stg}$	-65~+150	$^\circ\text{C}$

### Maximum Thermal Resistance

$T_j=25^\circ\text{C}$

Parameter	Test Conditions	Symbol	Value	Unit
Junction ambient	$l=9.5\text{mm}(3/8")$ $T_L=\text{constant}$	$R_{thJA}$	100	K/W

Stresses exceeding maximum ratings may damage the device. Maximum ratings are stress ratings only. Functional operation above the recommended operating conditions is not implied. Extended exposure to stresses above the recommended operating conditions may affect device reliability.

### Electrical Characteristics

$T_j=25^\circ\text{C}$

Parameter	Test Conditions	Type	Symbol	Min	Typ	Max	Unit
Forward voltage	$I_F=200\text{mA}$		$V_F$			1.2	V



Type	Device marking	$V_{Znom}^{1)}$	$I_{ZT}$ for $Z_{ZT}$		$Z_{ZK}$ at $I_{ZK}$		$I_R$ at $V_R$	
		V	mA	$\Omega$	$\Omega$	mA	$\mu A$	V
SMAZ5V1	Z5V1	5.1	100	<5	<500	1	<2.5	1
SMAZ5V6	Z5V6	5.6	100	<2	<250	2	<5	2
SMAZ6V2	Z6V2	6.2	100	<2	<200	2	<5	3
SMAZ6V8	Z6V8	6.8	100	<2	<200	1	<5	4
SMAZ7V5	Z7V5	7.5	100	<2	<450	1	<5	5
SMAZ8V2	Z8V2	8.2	100	<2	<200	1	<5	6
SMAZ9V1	Z9V1	9.1	50	<4	<200	1	<5	7
SMAZ10	Z10	10	50	<4	<200	1	<1	7.6
SMAZ12	Z12	12	50	<7	<150	1	<1	9.1
SMAZ15	Z15	15	50	<10	<150	1	<1	11.4
SMAZ16	Z16	16	25	<15	<150	1	<0.5	12.2
SMAZ18	Z18	18	25	<15	<150	1	<0.5	13.7
SMAZ20	Z20	20	25	<15	<180	1	<0.5	15.2
SMAZ22	Z22	22	25	<15	<180	1	<0.5	16.7
SMAZ24	Z24	24	25	<15	<180	1	<0.5	18.2
SMAZ27	Z27	27	25	<15	<200	1	<0.5	20.5
SMAZ30	Z30	30	25	<15	<250	1	<0.5	22.8
SMAZ33	Z33	33	25	<15	<300	1	<0.5	25.1
SMAZ36	Z36	36	10	<40	<350	1	<0.5	27.4
SMAZ39	Z39	39	10	<40	<450	1	<0.5	29.6

1) Based on DC-measurement at thermal equilibrium while maintaining the lead temperature( $T_L$ )at 30°C, 9.5mm(3/8") from the diode body.



Characteristics ( $T_j=25^\circ\text{C}$  unless otherwise specified)

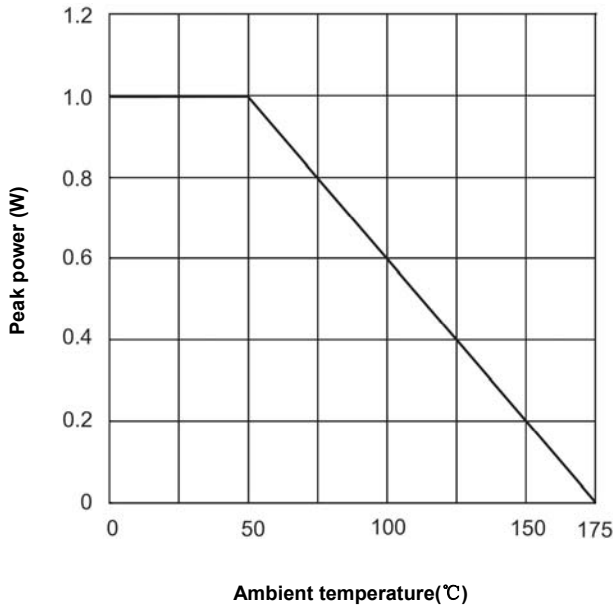

Fig.1 Power dissipation vs ambient temperature

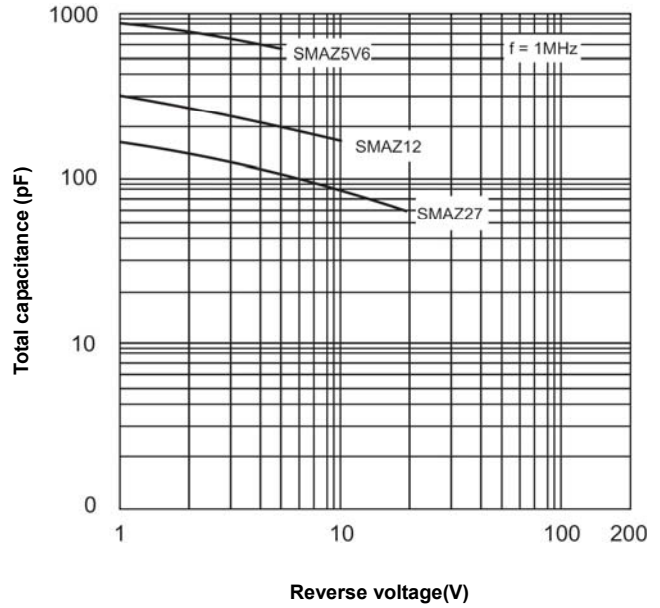

Fig.2 Total capacitance vs reverse voltage

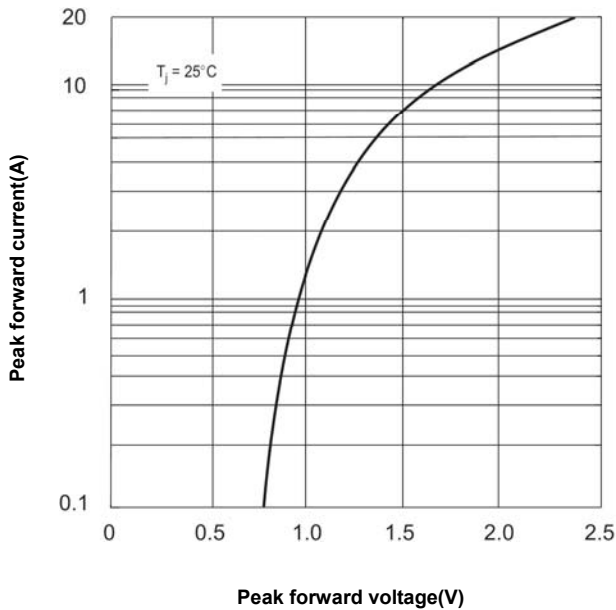

Fig.3 Peak forward current vs peak forward voltage

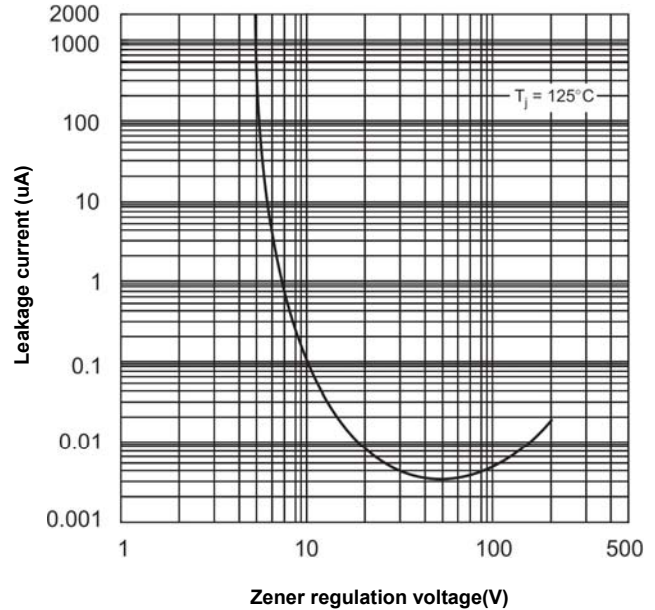
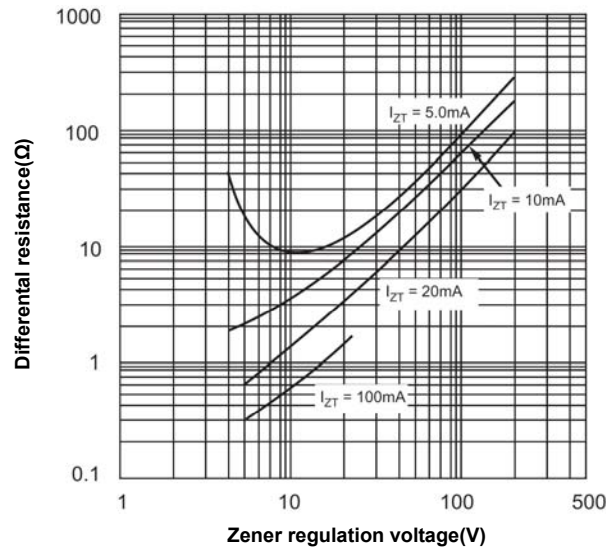
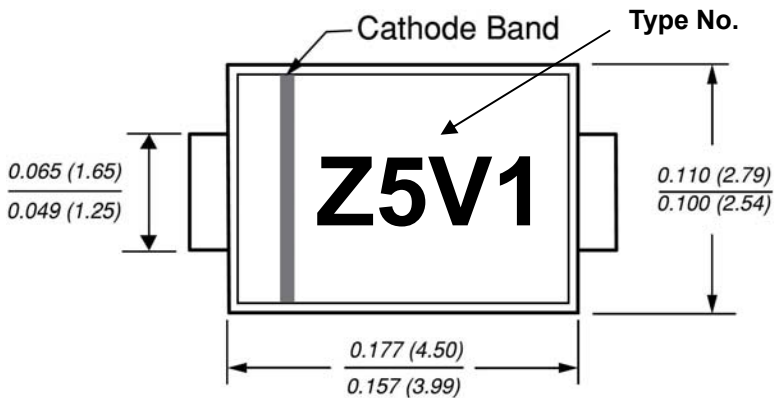

Fig.4 Leakage current vs regulation voltage

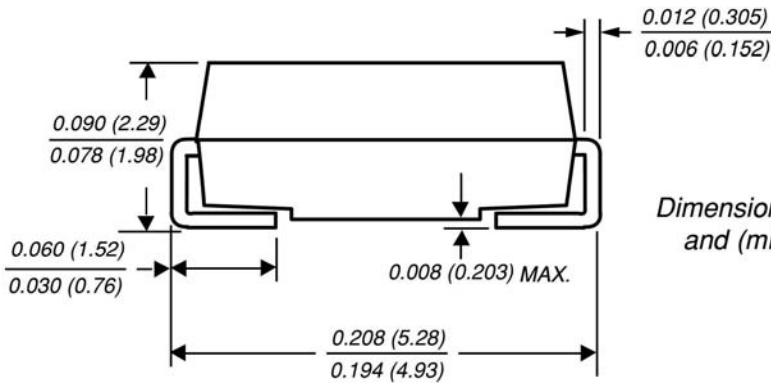
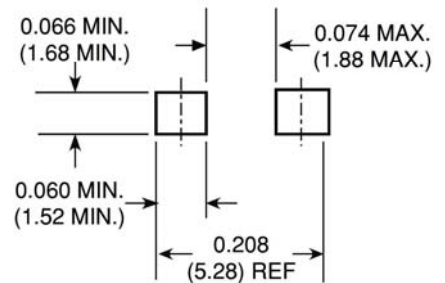

**Fig.5 Differential resistance regulation voltage**

**Dimensions in inches (mm)**



**Mounting Pad Layout**



*Dimensions in inches and (millimeters)*

DO-214AC (SMA)

**Excel Semiconductor**